

Design and model by WW2CustomBrickModels

www.ww2custombrickmodels.de

Vertriebshändler: www.Bricklands.net

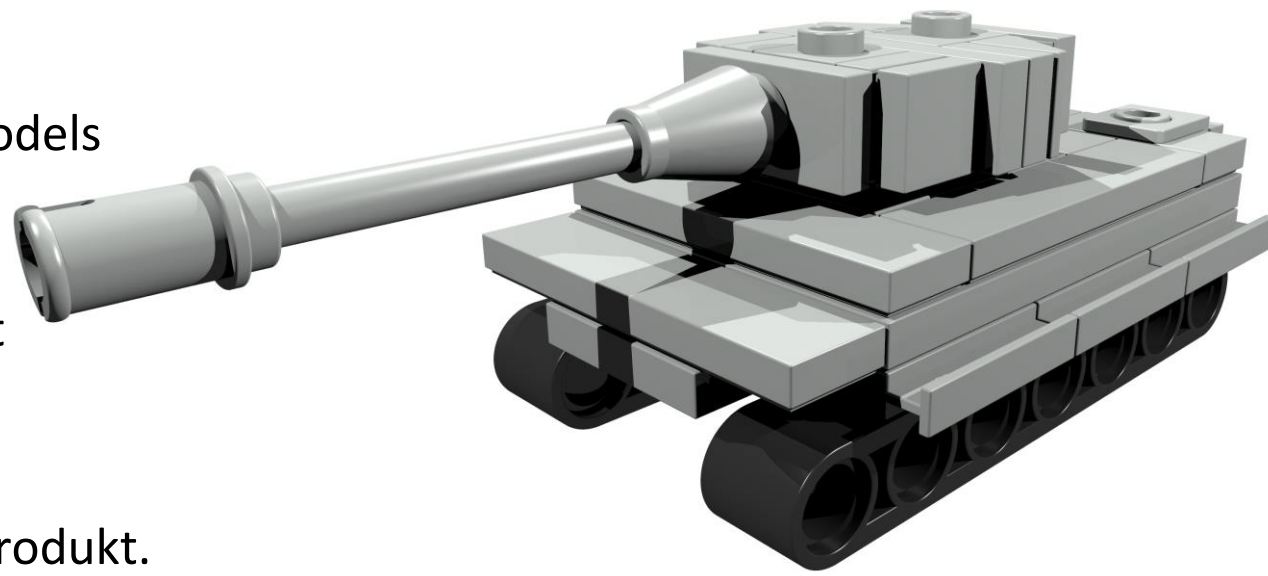

Kein original LEGO® Produkt.

Der Markenname LEGO® wird nur zur Verdeutlichung der Qualität benutzt.

LEGO® hat diese Seite weder gesponsert noch autorisiert.

LEGO® ist ein eingetragenes Warenzeichen der LEGO® Gruppe die diese Seite/dieses Produkt nicht autorisiert, gesponsert oder genehmigt hat!

Rechte/Copyright Inhaber ist ww2custombrickmodels.

Autorisierter Verkäufer

Umsatzsteuer befreit nach §19 UST Gesetz, da Kleinunternehmer.

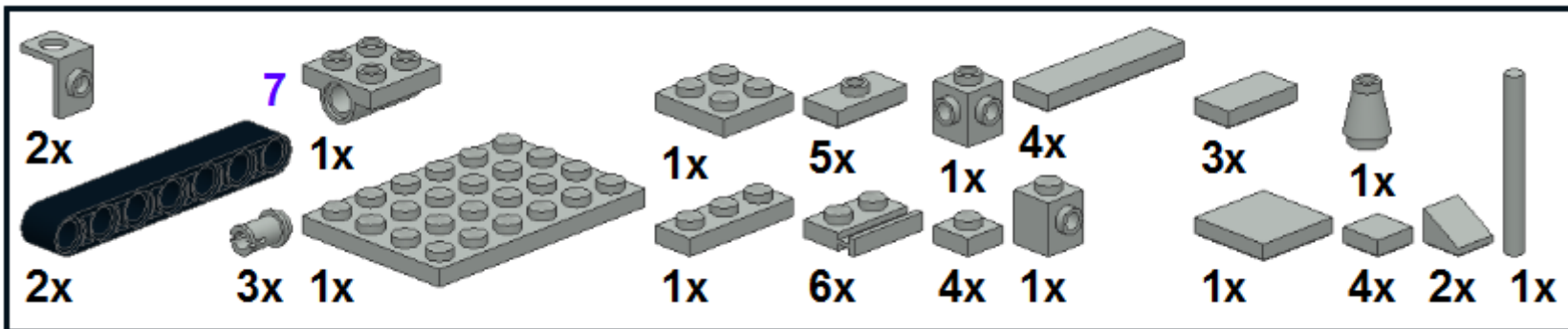

Instructions by Frank Müller
amantido@outlook.de

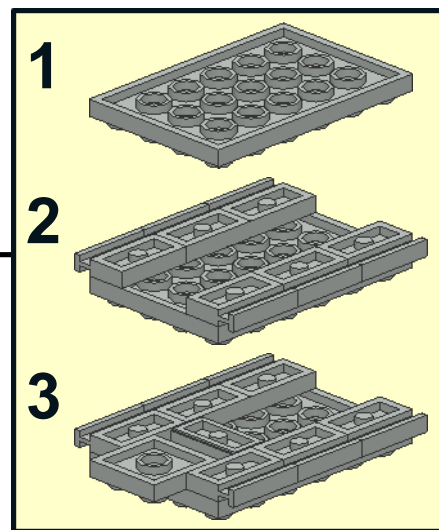
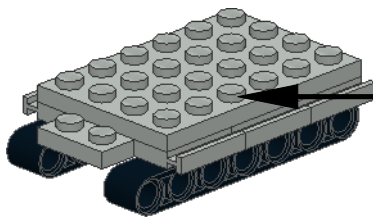
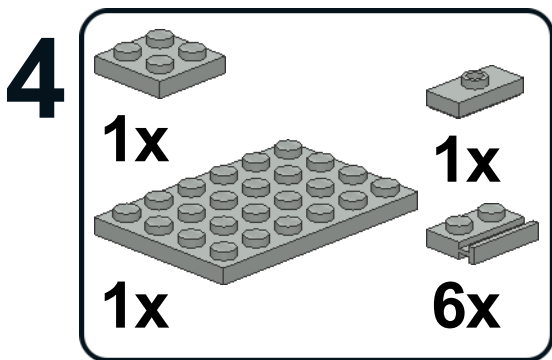
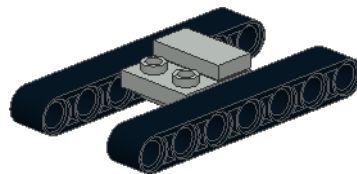
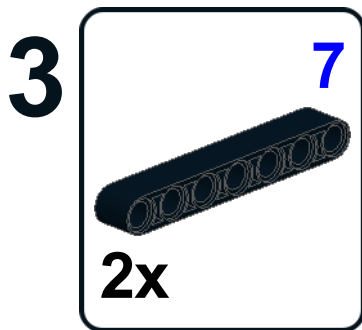
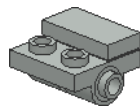
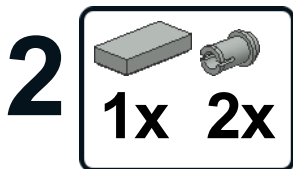
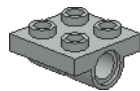
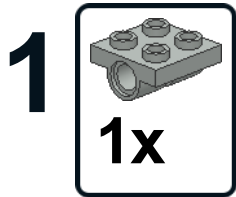

5

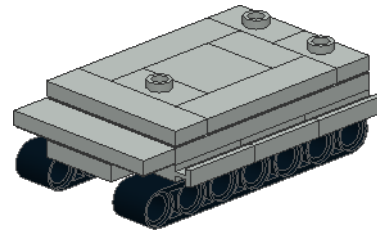
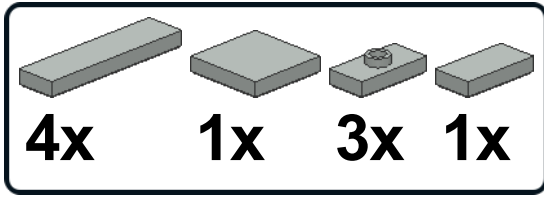



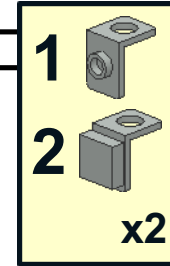
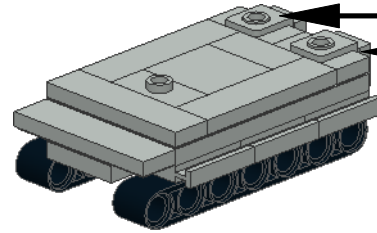
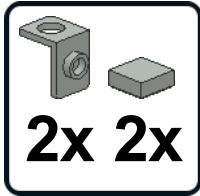



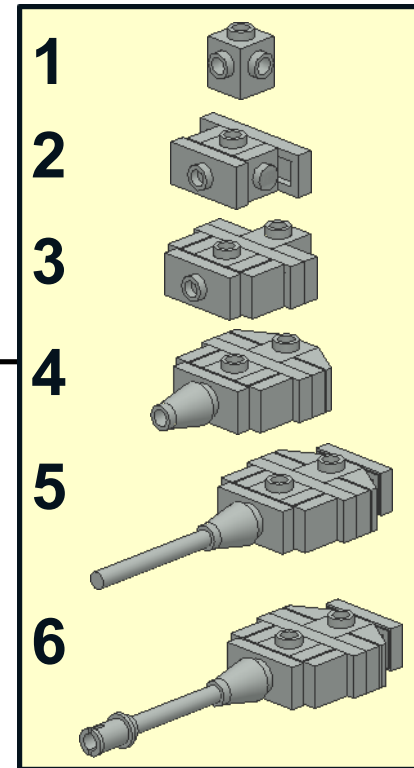
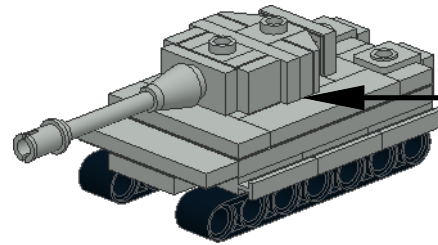
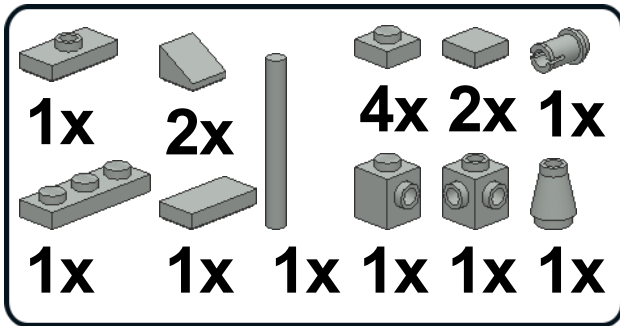

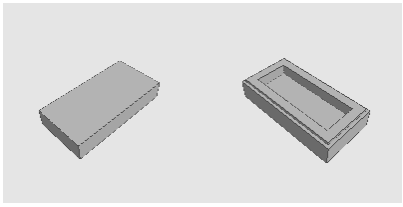

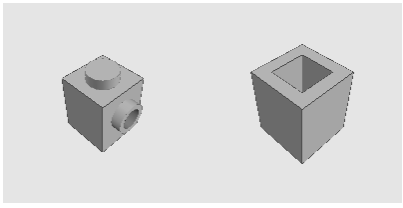

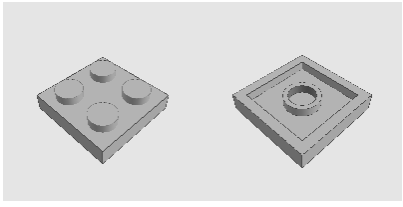

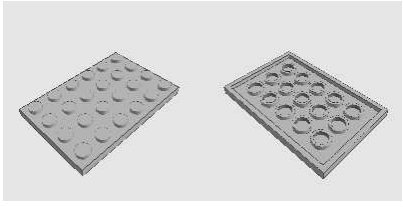

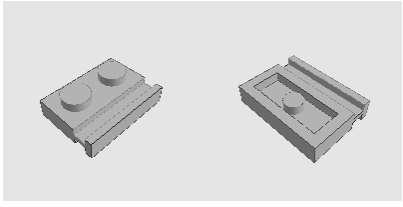

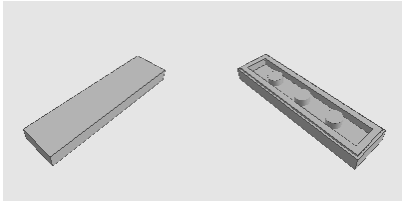

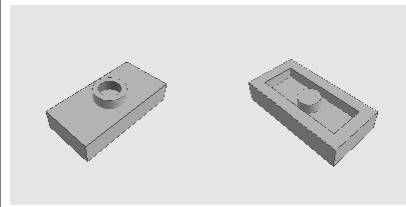

6

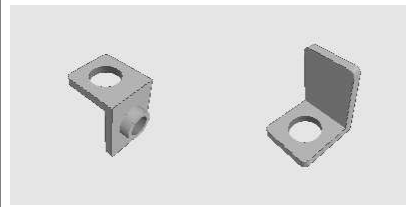

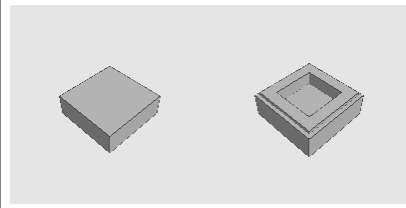

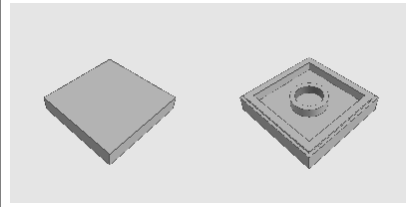

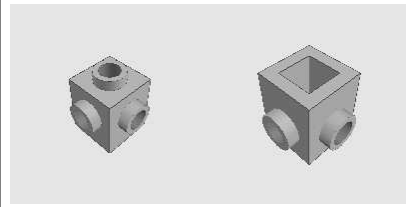

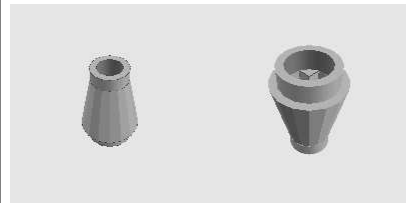

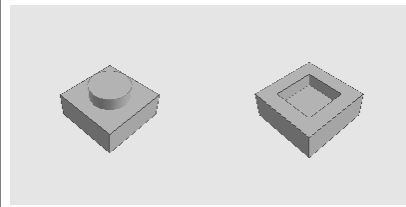

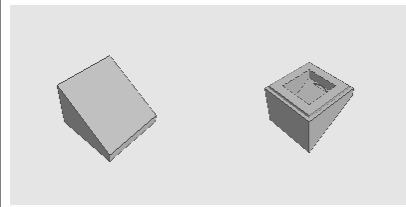

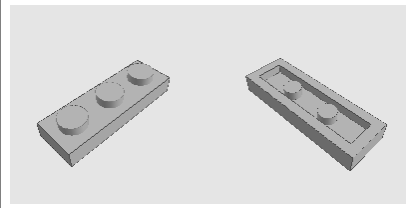
7

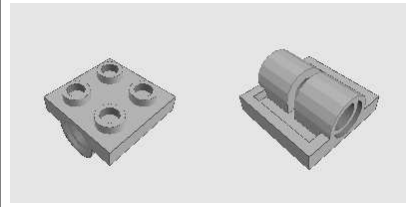

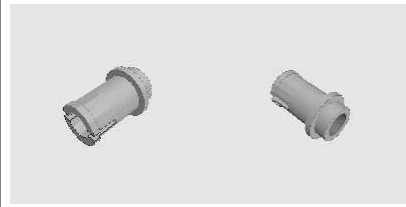
ID	LDD ID	BLink ID	LDraw ID	Color	Qty	Brick shape	Description
1	3069	3069b	3069b.dat	194  Medium Stone Grey	3		Tile 1 x 2 with Groove
2	87087	87087	87087.dat	194  Medium Stone Grey	1		Brick, Modified 1 x 1 with Stud on 1 Side
3	3022	3022	3022.dat	194  Medium Stone Grey	1		Plate 2 x 2
4	3032	3032	3032.dat	194  Medium Stone Grey	1		Plate 4 x 6
5	32028	32028	32028.dat	194  Medium Stone Grey	6		Plate, Modified 1 x 2 with Door Rail
6	2431	2431	2431.dat	194  Medium Stone Grey	4		Tile 1 x 4

ID	LDD ID	BLink ID	LDraw ID	Color	Qty	Brick shape	Description
7	3794	3794	3794.dat	194  Medium Stone Grey	5		Plate, Modified 1 x 2 with 1 Stud (Jumper)
8	42446	42446	42446.dat	194  Medium Stone Grey	2		Minifig, Neck Bracket with Back Stud
9	3070	3070b	3070b.dat	194  Medium Stone Grey	4		Tile 1 x 1 with Groove
10	3068	3068b	3068b.dat	194  Medium Stone Grey	1		Tile 2 x 2 with Groove
11	4733	4733	4733.dat	194  Medium Stone Grey	1		Brick, Modified 1 x 1 with Studs on 4 Sides
12	4589	4589	4589.dat	194  Medium Stone Grey	1		Cone 1 x 1 without Top Groove

ID	LDD ID	BLink ID	LDraw ID	Color	Qty	Brick shape	Description
13	3024	3024	3024.dat	194  Medium Stone Grey	4		Plate 1 x 1
14	50746	54200	50746.dat	194  Medium Stone Grey	2		Slope 30 1 x 1 x 2/3
15	3623	3623	3623.dat	194  Medium Stone Grey	1		Plate 1 x 3
16	2817	2817	2817.dat	194  Medium Stone Grey	1		Plate, Modified 2 x 2 with Pin Holes
17	4274	4274	4274.dat	194  Medium Stone Grey	3		Technic, Pin 1/2
18	32524	32524	32524.dat	26  Black	2		Technic, Liftarm 1 x 7 Thick

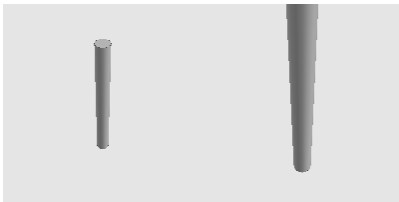
ID	LDD ID	BLink ID	LDraw ID	Color	Qty	Brick shape	Description
19	30374	30374	30374.dat	194  Medium Stone Grey	1		Bar 4L (Lightsaber Blade / Wand)